

① SCREW DRIVER

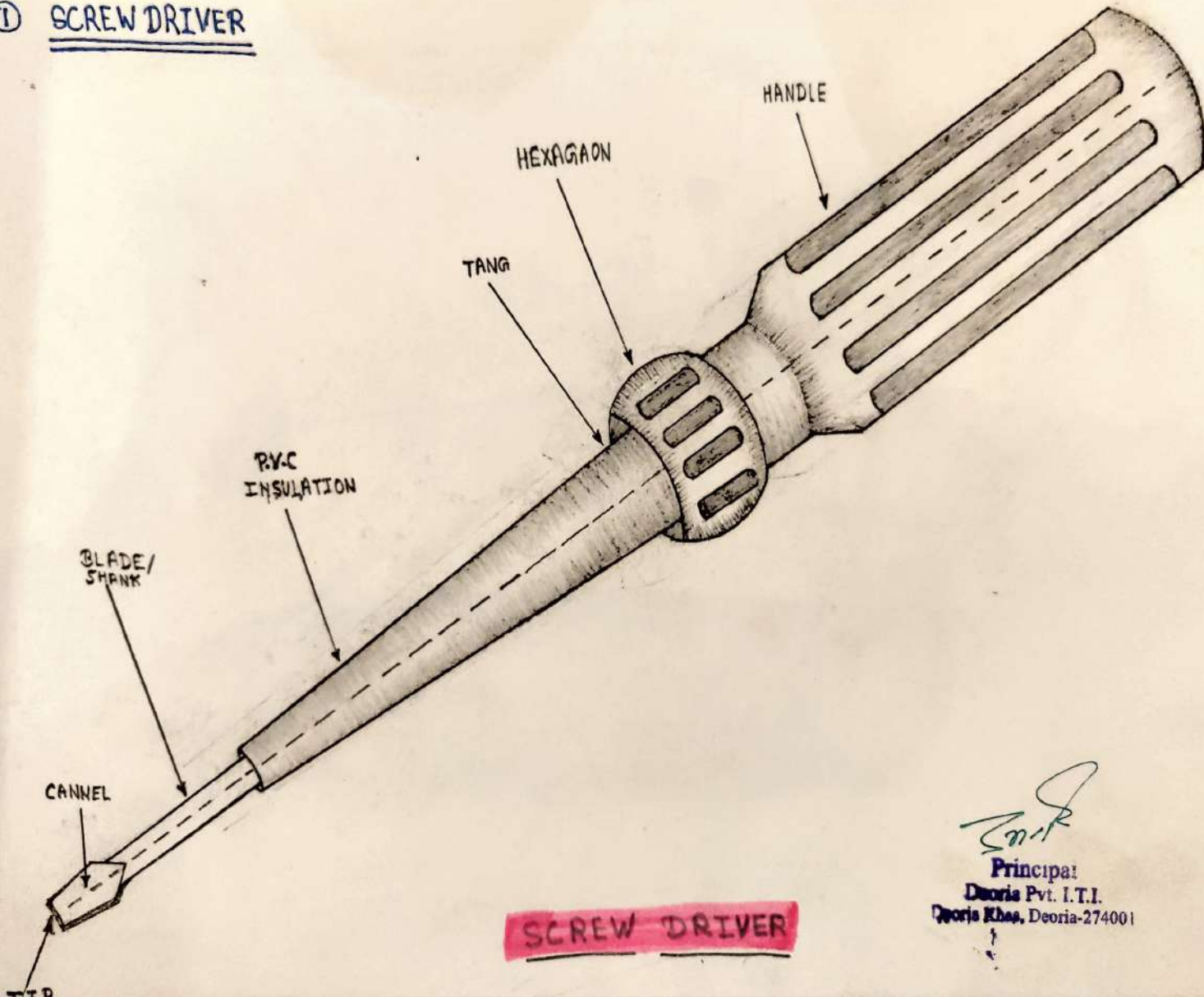

SCREW DRIVER

[Signature]
Principal
Deoria Pvt. I.T.I.
Deoria Khas, Deoria-274001

② ELECTRICIAN KNIFE

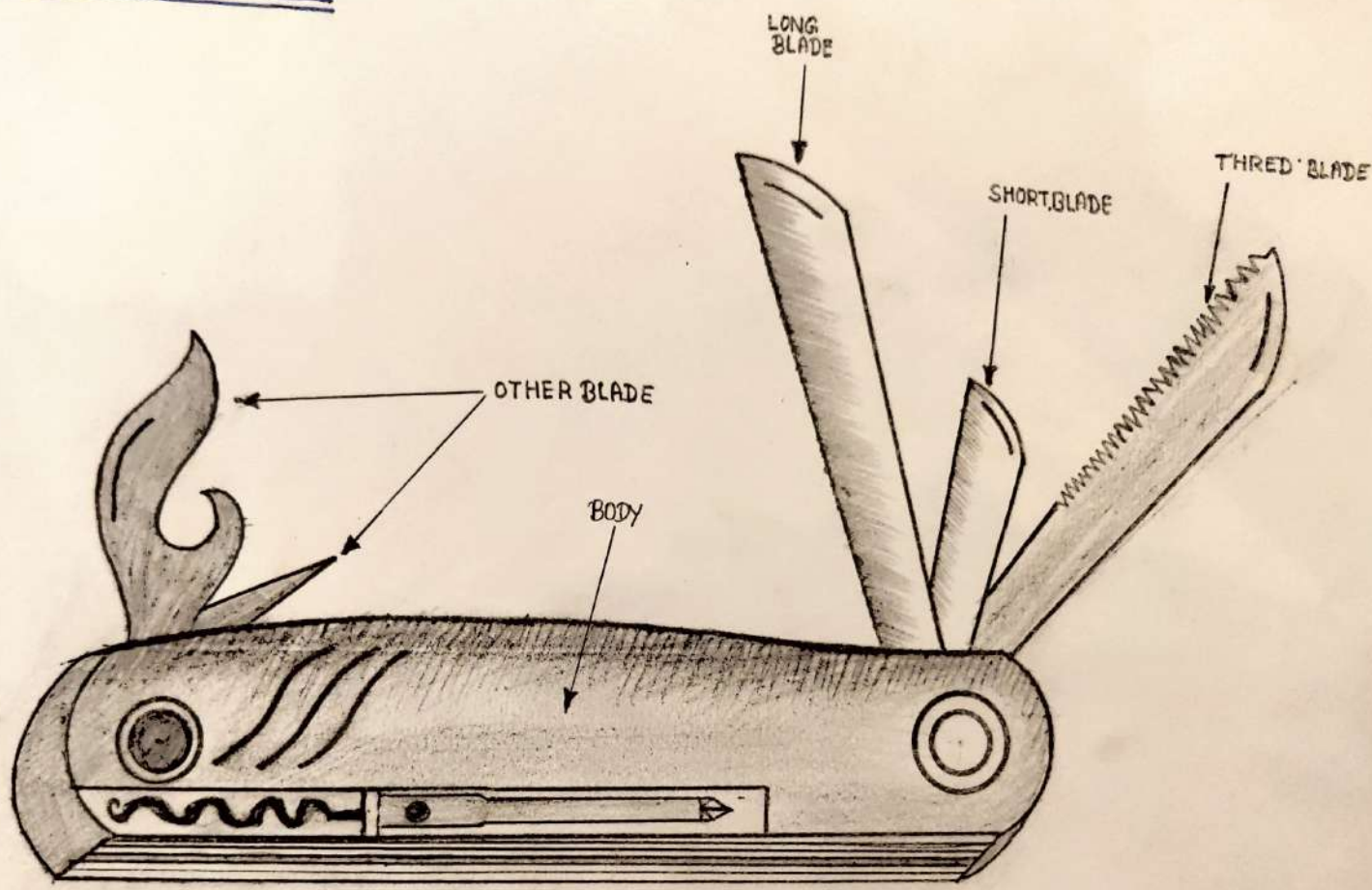

ELECTRICIAN KNIFE

Principal
Principal
Deoria Pvt. I.T.I.
Deoria Khas, Deoria-274001

⑬ C-CLAMP

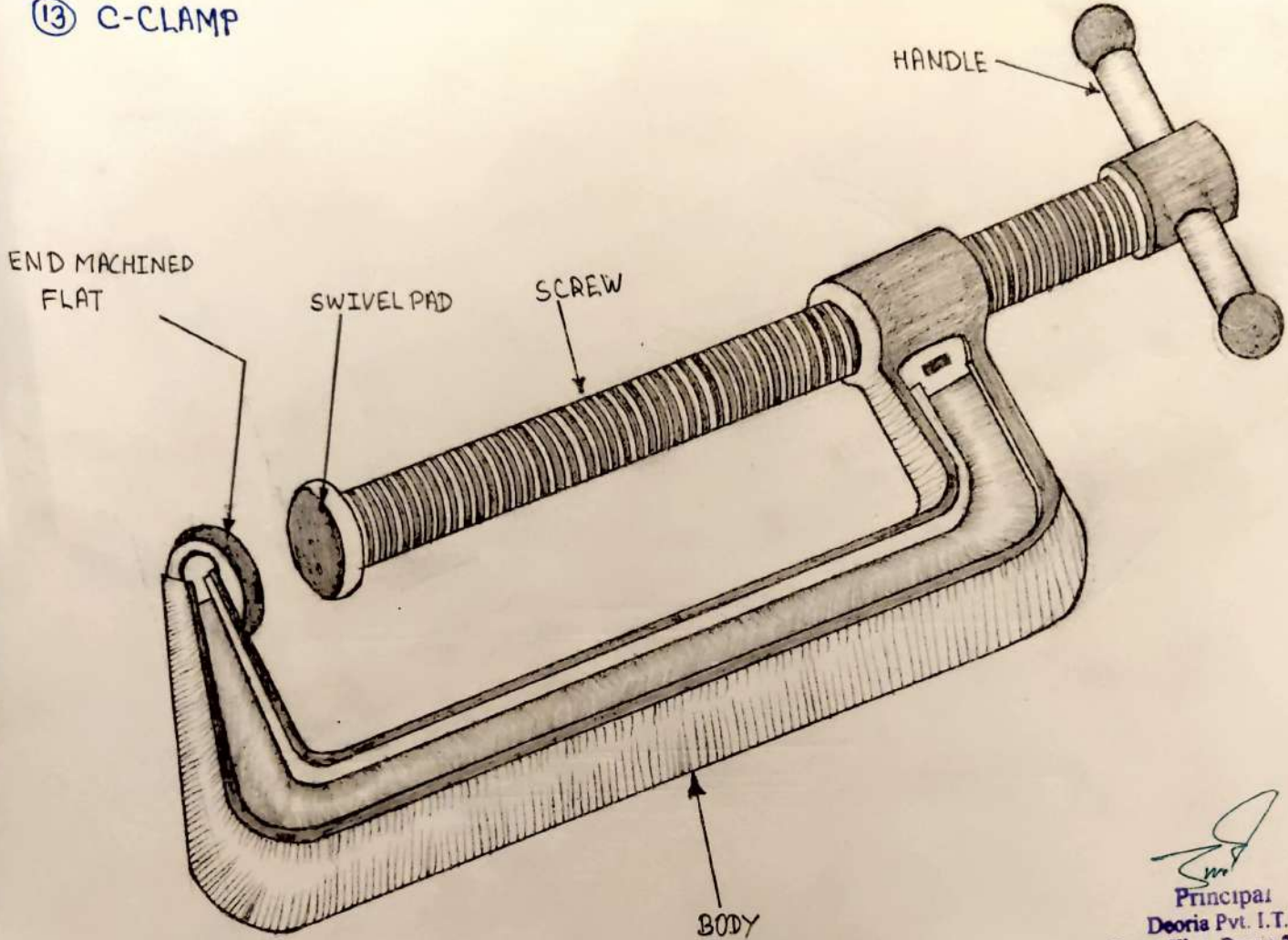

END MACHINED
FLAT

SWIVEL PAD

SCREW

HANDLE

BODY

C-CLAMP

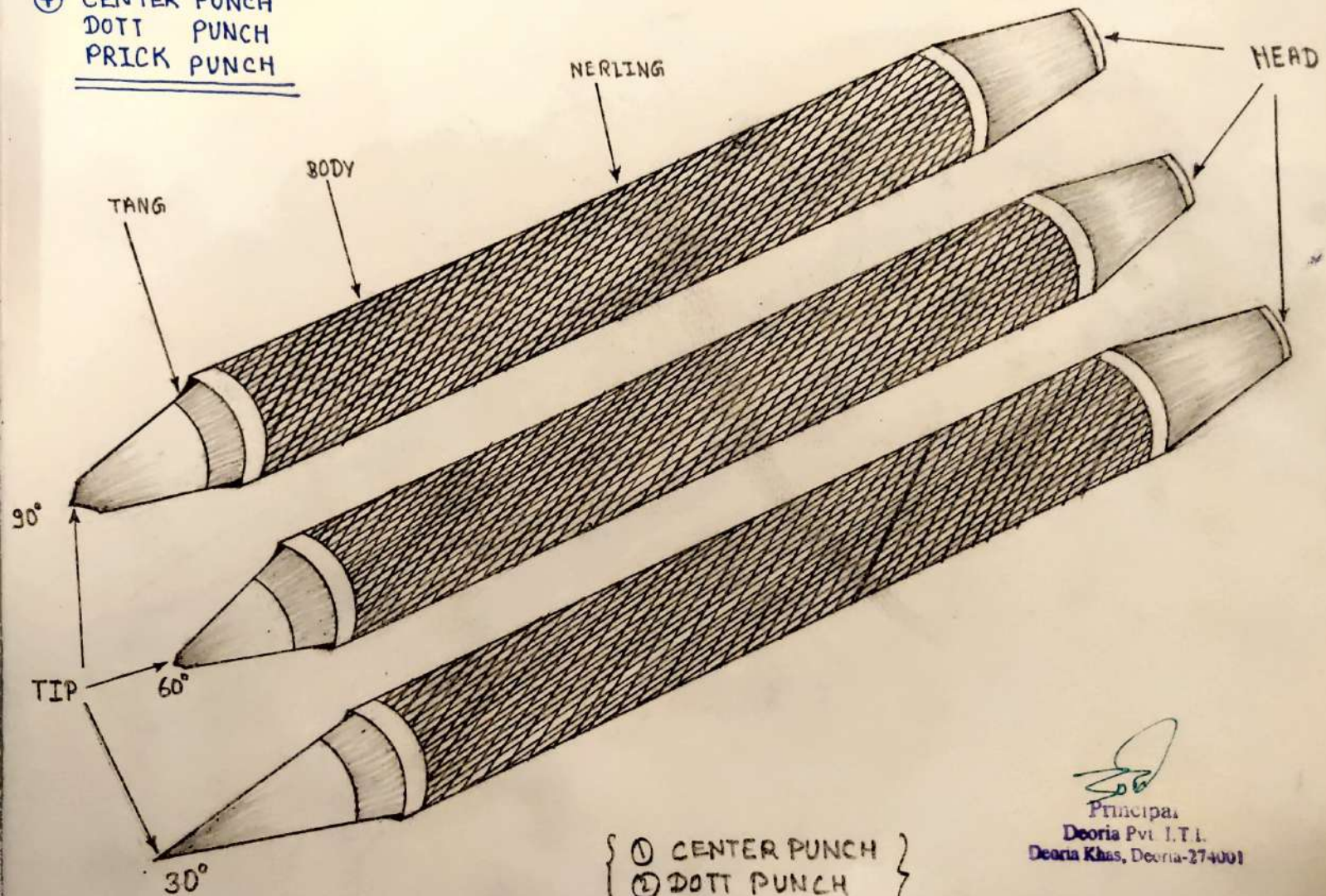

Principal
Deoria Pvt. I.T.I.
Deoria Khas, Deoria-274001

④ CENTER PUNCH
DOTT PUNCH
PRICK PUNCH

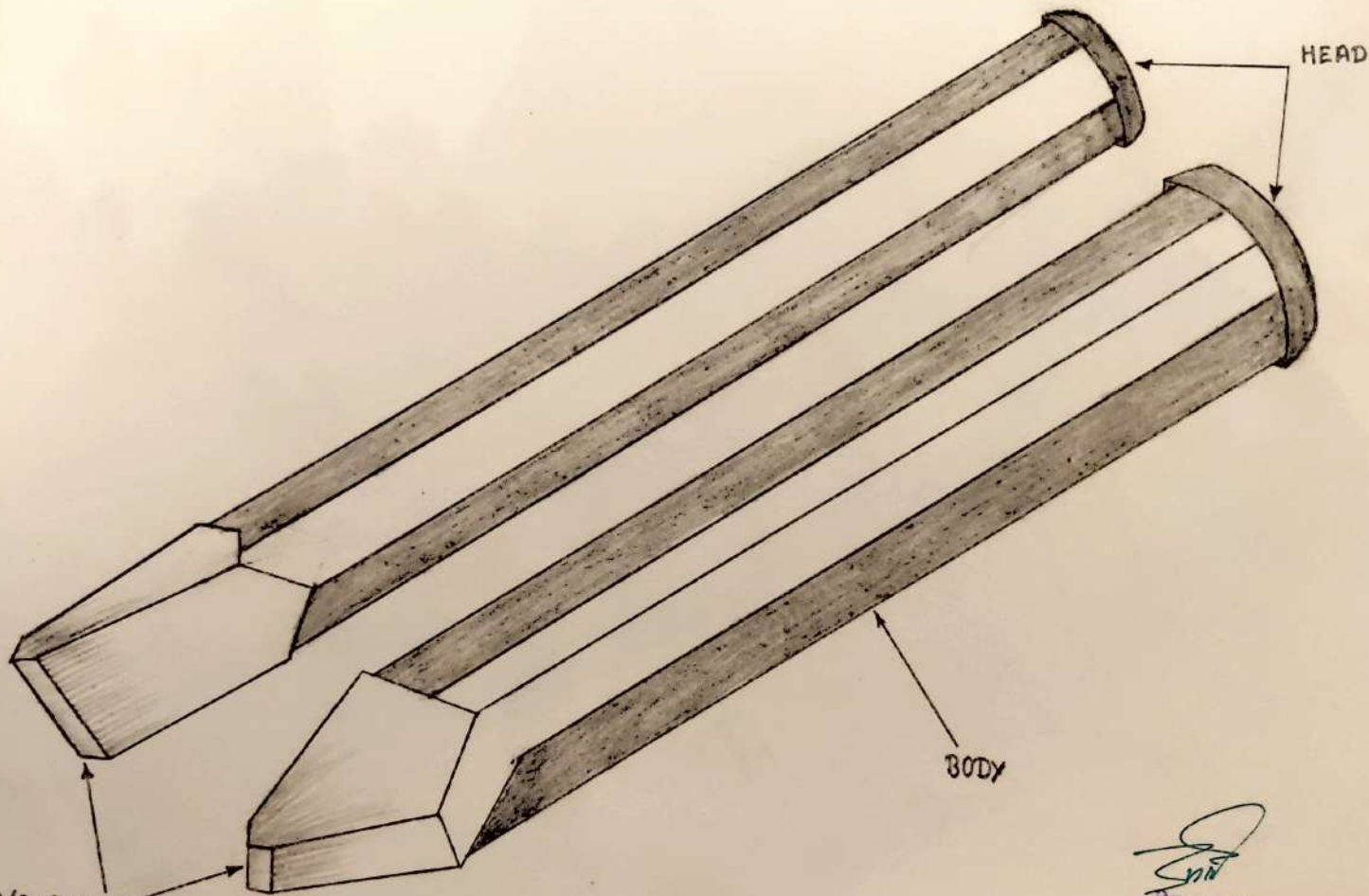

- ① CENTER PUNCH
- ② DOTT PUNCH
- ③ PRICK PUNCH

Principal
Deoria Pvt. I.T.I.
Deoria Khas, Deoria-274001



TIP/BLADE

CHISEL'S

Principal,
Deoria Pvt. L.T.L.
Deoria Khas, Deoria-274001

⑥ FLAT FILE

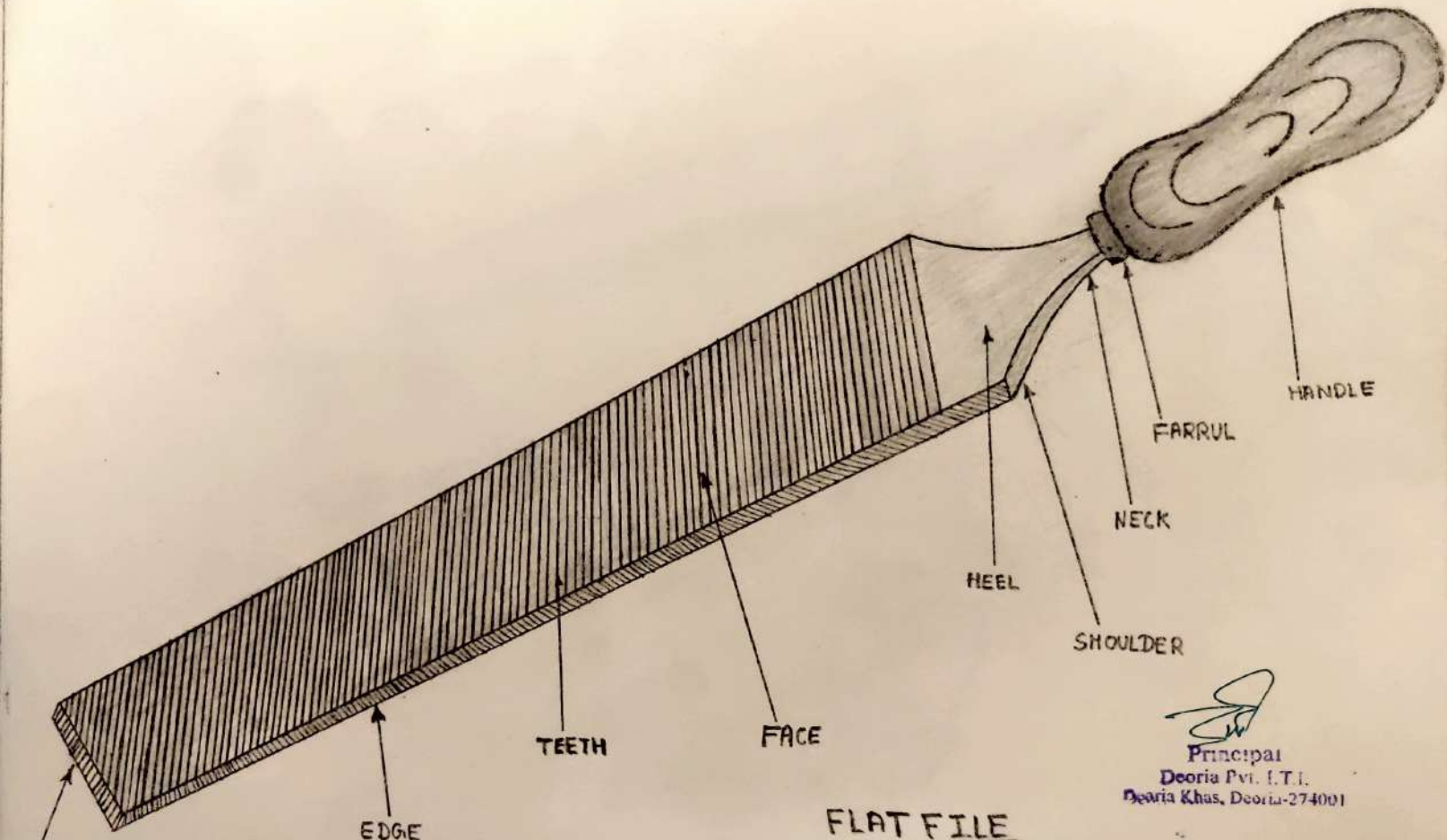

FLAT FILE

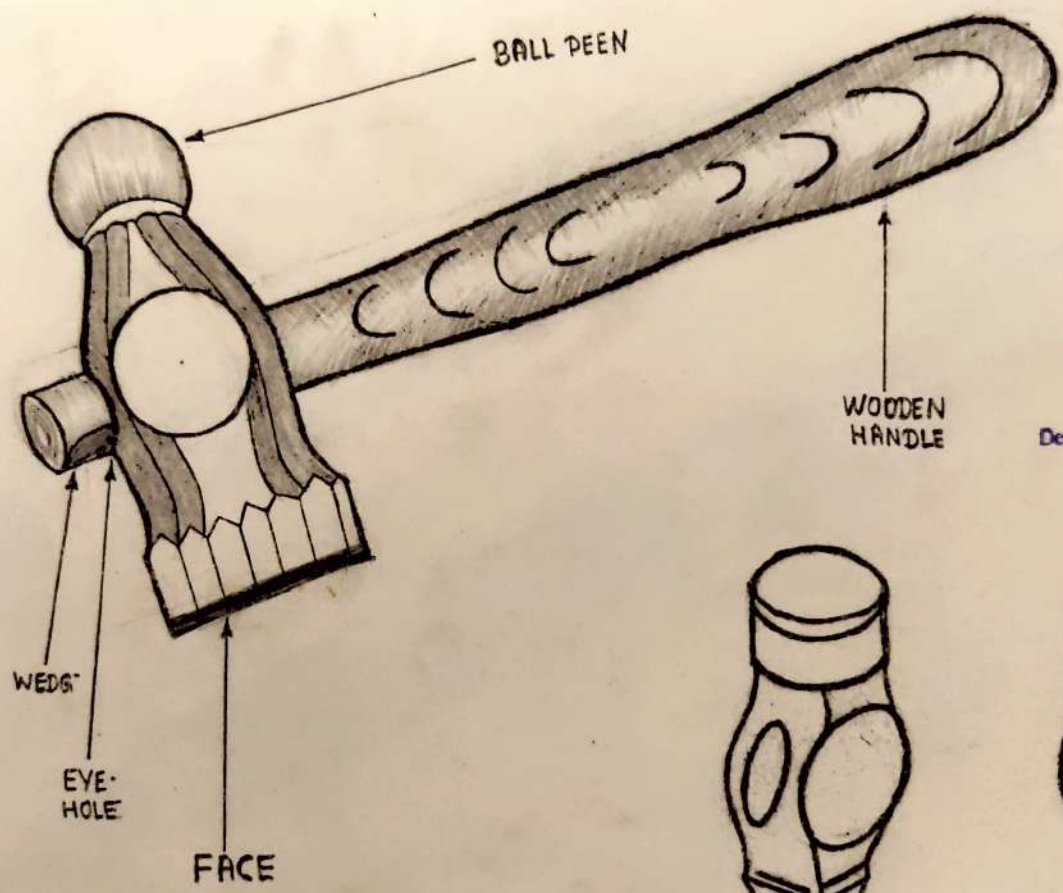

Principal
Deoria Pvt. I.T.I.
Deoria Khas, Deoria-274001

⑦ HAMMER

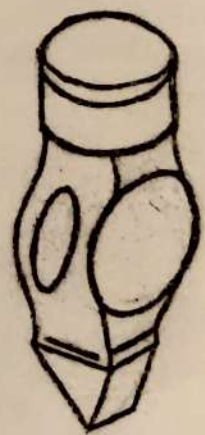

[Signature]
 Principal
 Deoria P.V. I.T.I.
 Deoria Khas, Deoria-274001

BALL PEEN HAMMER



STRAIGHT PEEN HAMMER

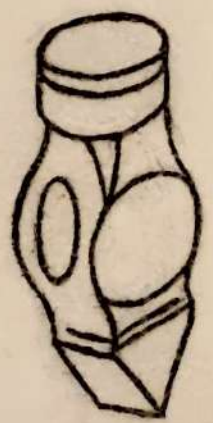

CROSS PEEN HAMMER

⑧ STRAIGHT SCRIBER
BENT SCRIBER

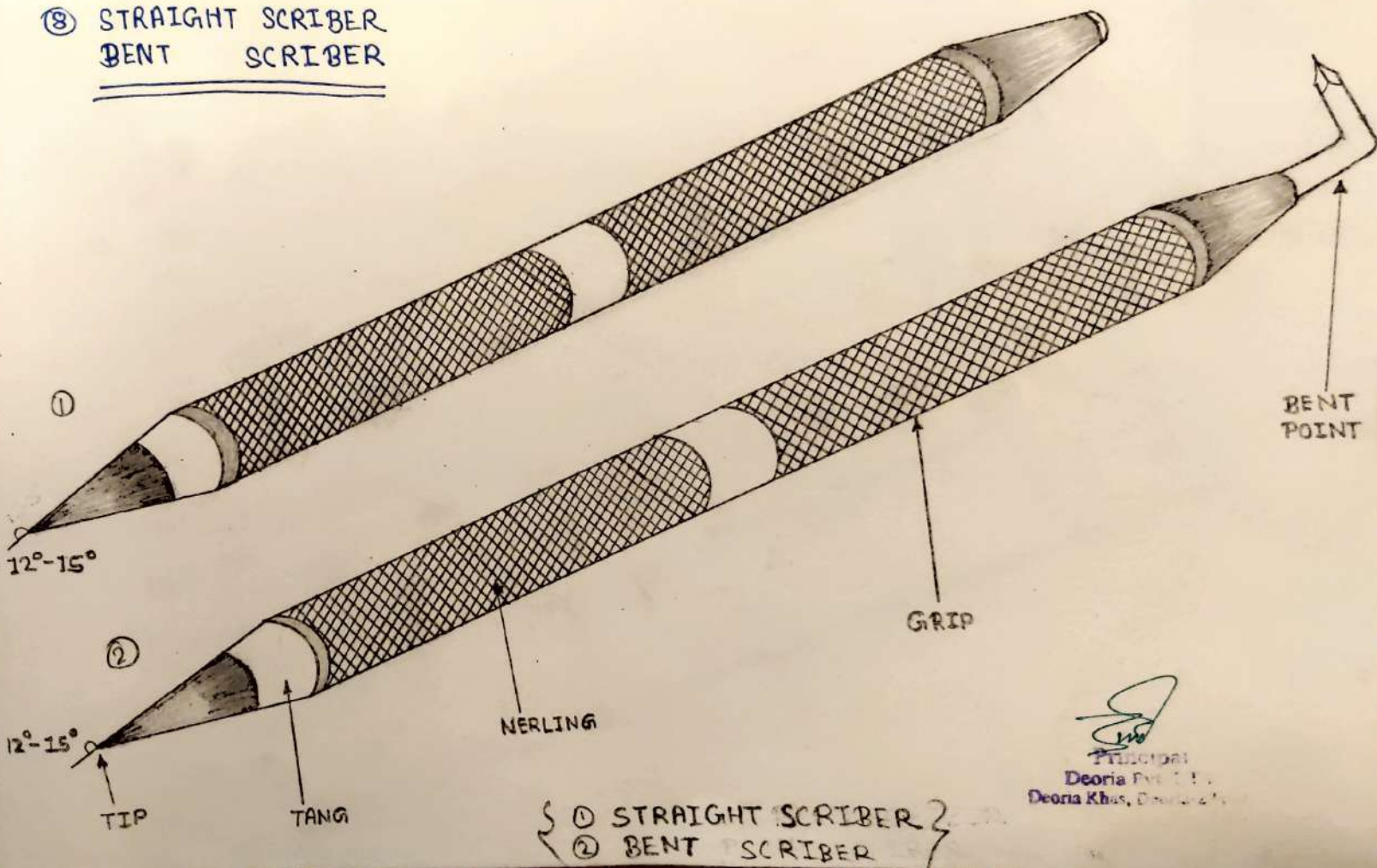

①
12°-15°

②
12°-15°
TIP
TANG

NERLING

GRIP

BENT POINT

{ ① STRAIGHT SCRIBER }
{ ② BENT SCRIBER }

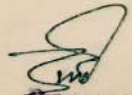
Principal
Deoria P.S. H.S.
Deoria Khas, Deoria

⑨ TRY SQUARE

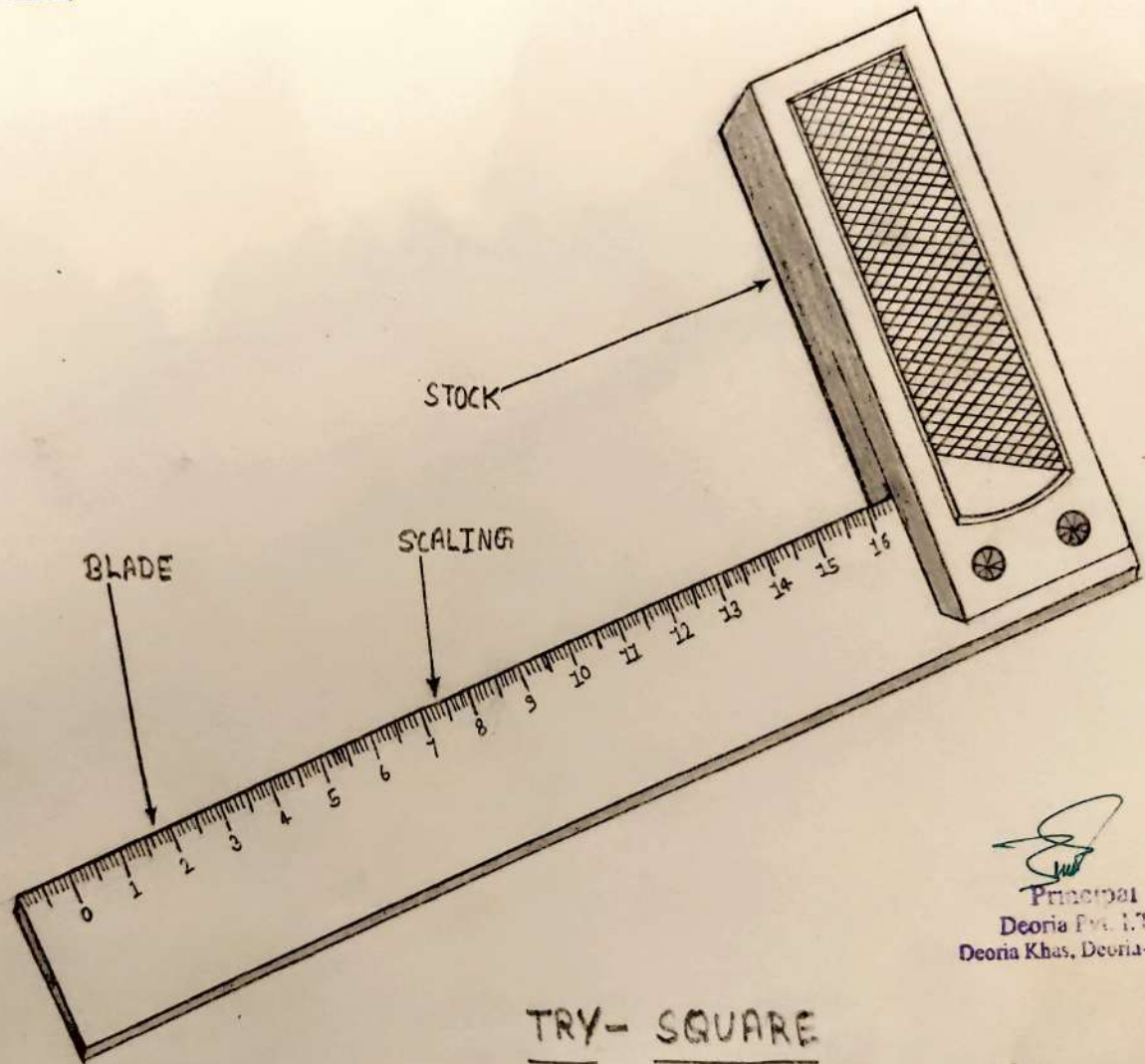

Principal
Deoria P.V. I.T.I.
Deoria Khas, Deoria-274001

TRY-SQUARE

⑩ FIXED FRAME HACKSAW
WITH BLADE

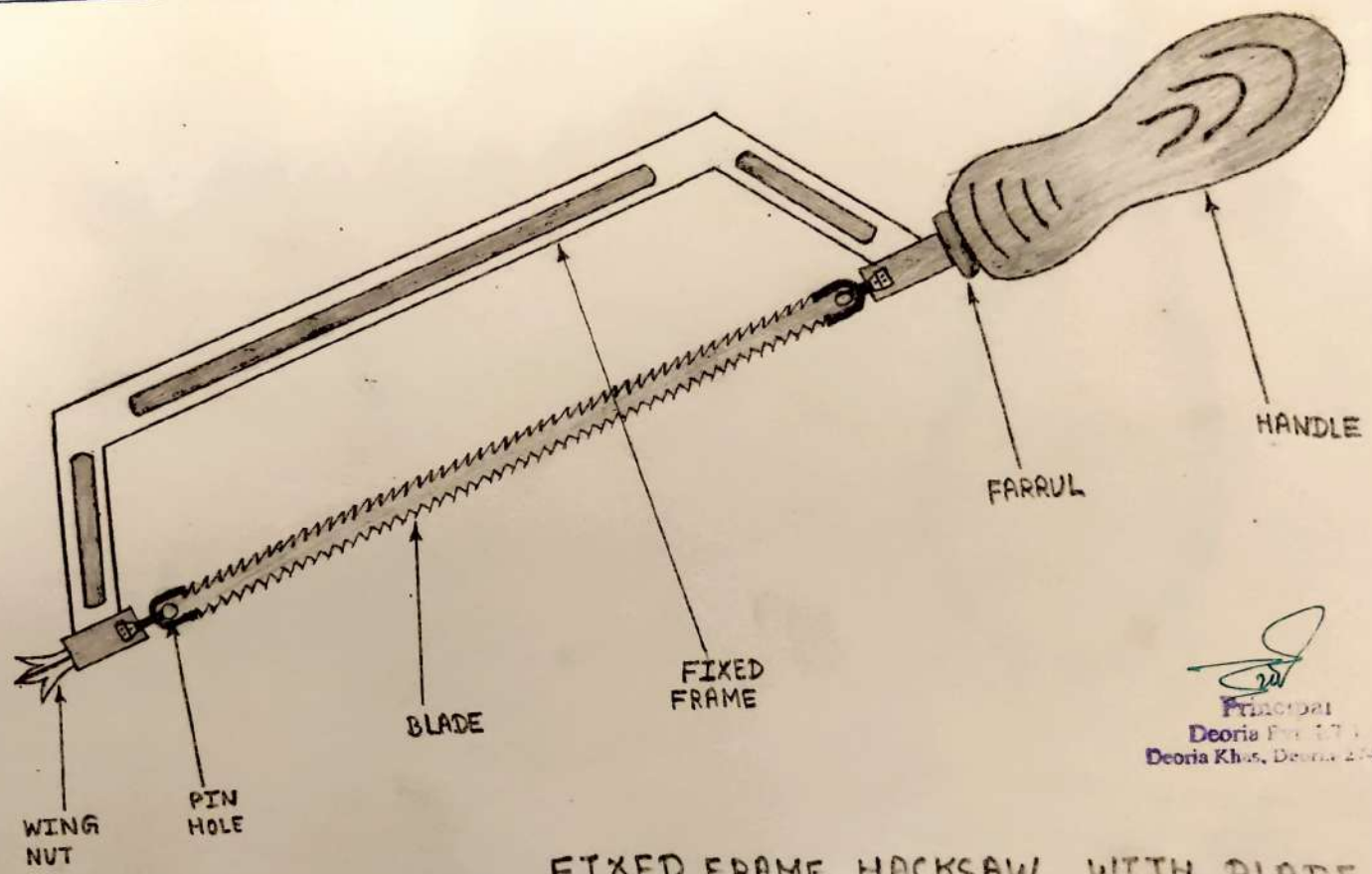

[Signature]
Principal
Deoria P.S. 171
Deoria Khas, Deoria 224001

FIXED FRAME HACKSAW WITH BLADE

(11)

OUT SIDE CALIPER

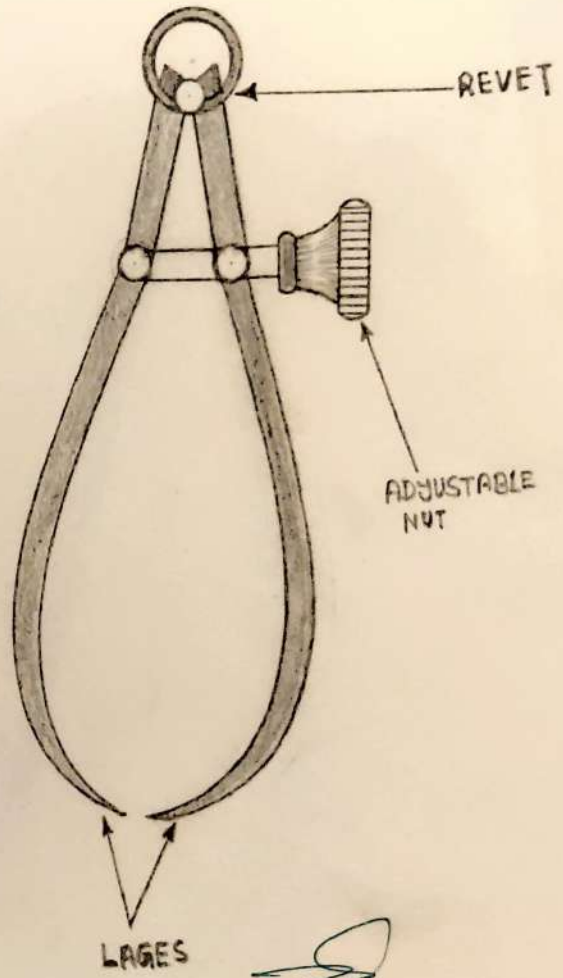
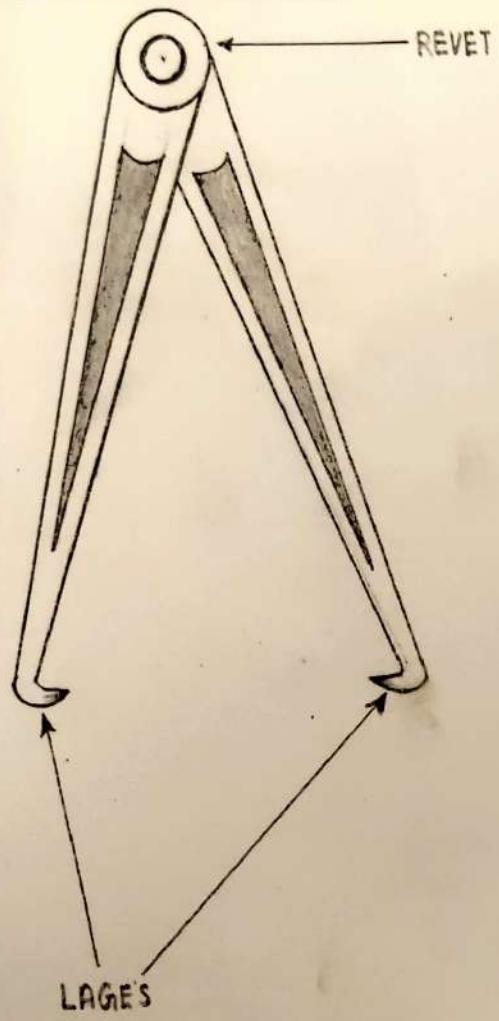

OUT SIDE CALIPER

[Signature]
Principal
Deoria P.S.
Deoria Khas, Deoria-224001

⑫ IN-SIDE CALIPER

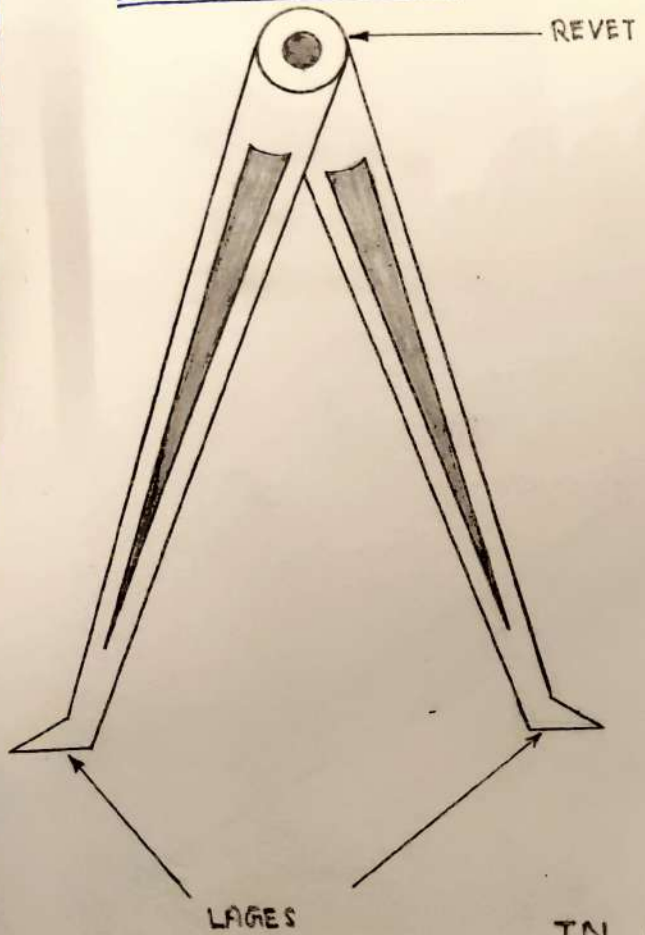

[Signature]
Principal
Deoria Pvt. I.T.I.
Deoria Khas, Deoria-274601

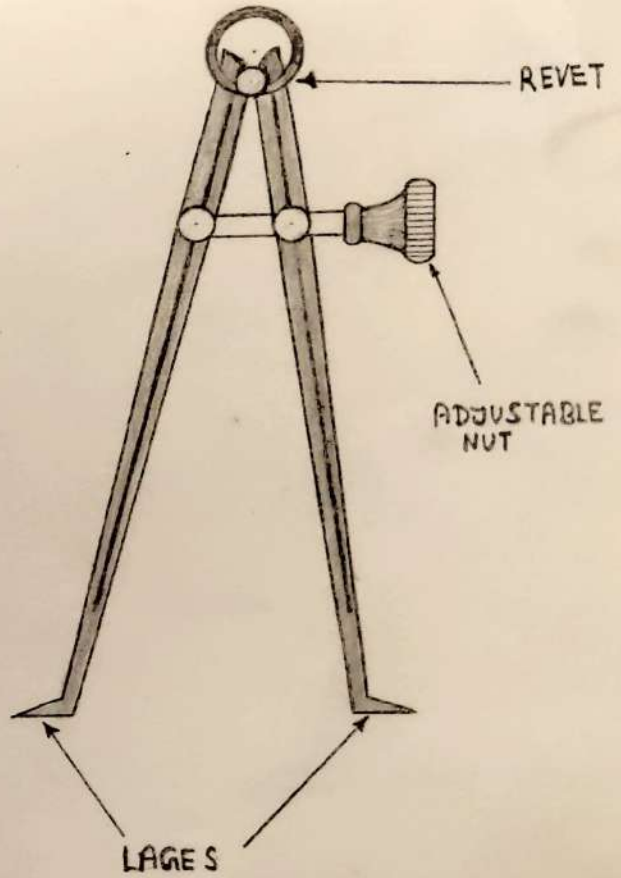

IN SIDE CALIPER

13 NEON TESTER

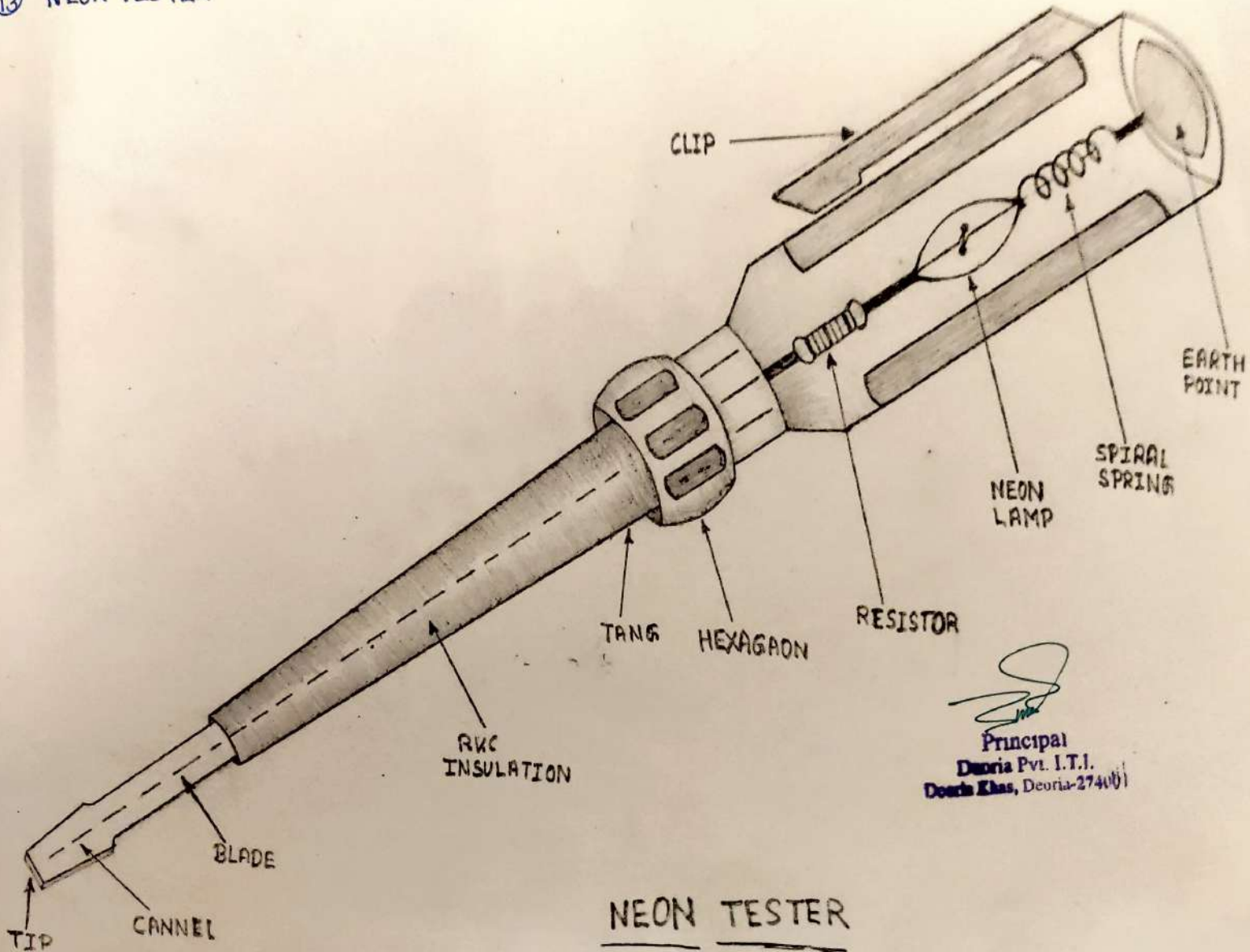

Principal
Deoria Pvt. I.T.I.
Deoria Khas, Deoria-274001

NEON TESTER

14) COMBINATION PLIER'S

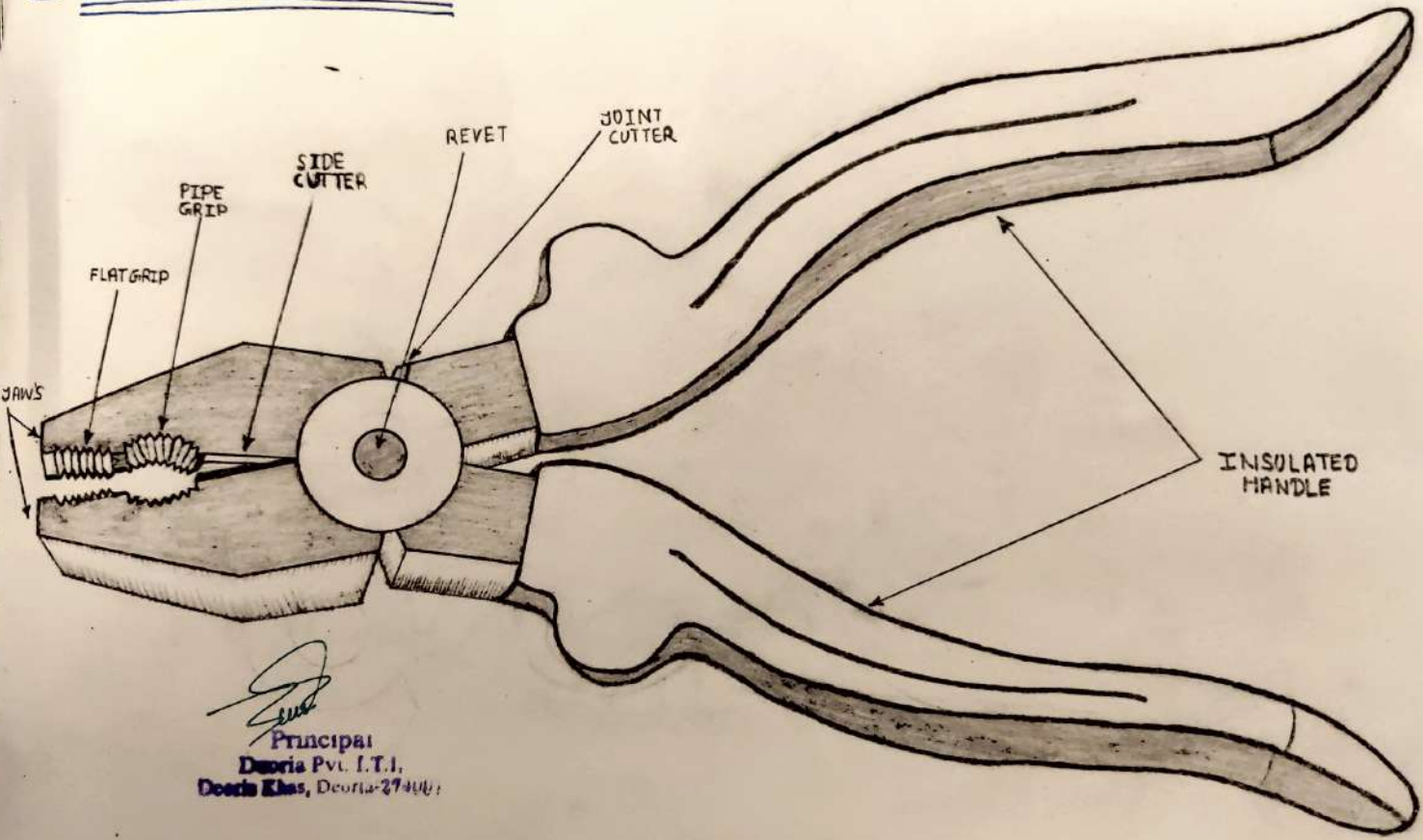

[Signature]
Principal
Deoria Pvt. I.T.I.,
Deoria Khas, Deoria-274001

COMBINATION PLIER'S

15 S.W.G → STANDERD WIRE GAUGE

TRIT- 617/21

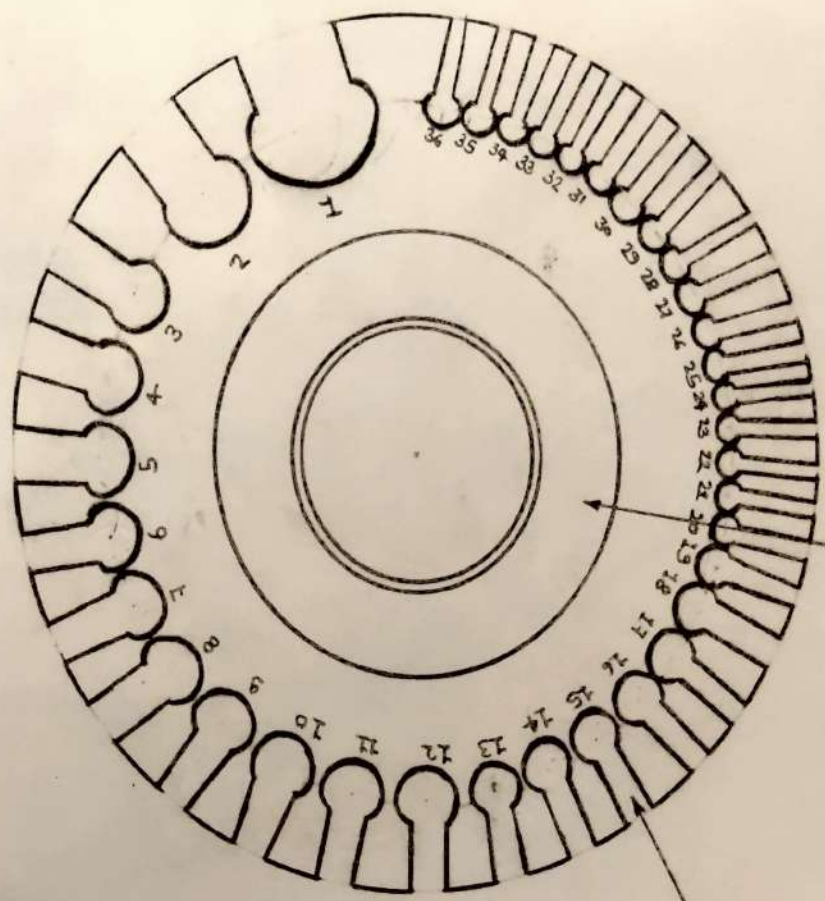

STEELNESS ST

Principal
Deoria P.V. I.T.E.
Deoria Khas, District-274001

SURFACE AREA

S.W.G → STANDERD WIRE GAUGE

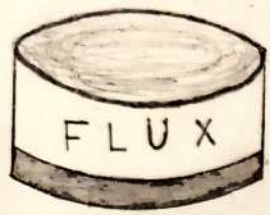

SOLDER

BODY

SOLDERING IRON

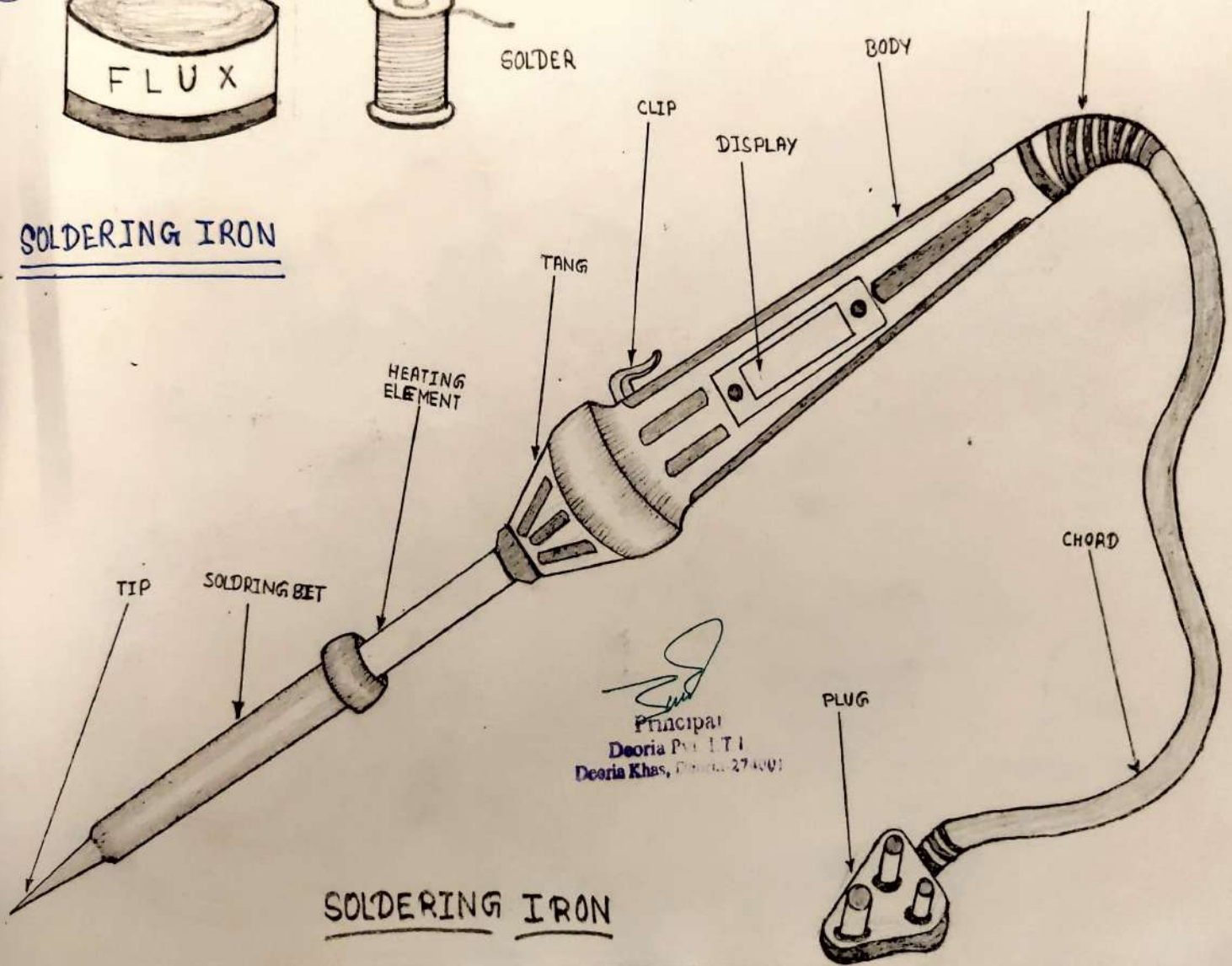

[Signature]
Principal
Deoria P.S. I.T. I
Deoria Khas, Distt. 274001

SOLDERING IRON

17 OUT SIDE MICROMETER

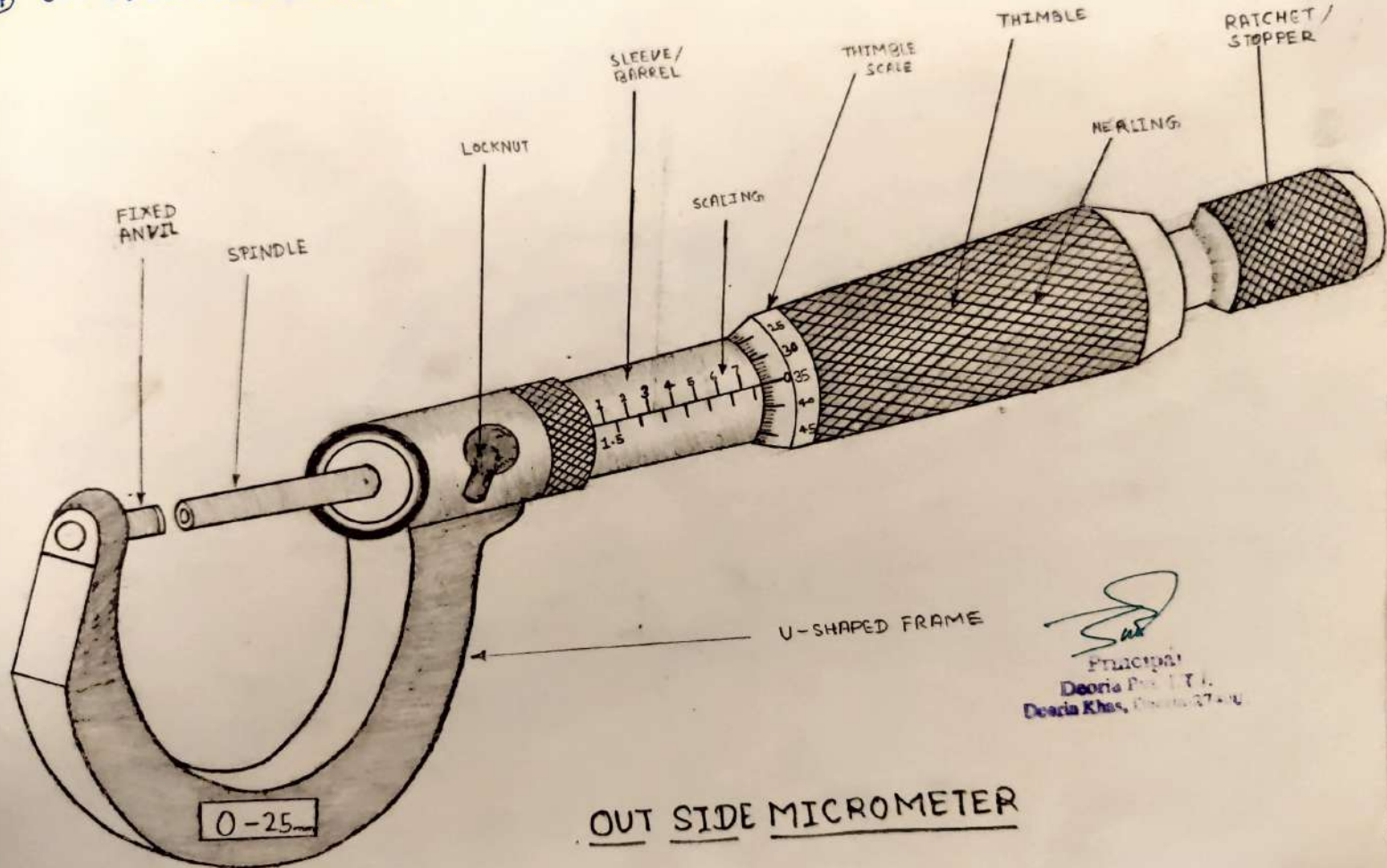

[Signature]
Principal
Deoria P.S. T.T.
Deoria Khas, Dist. Gorakhpur

OUT SIDE MICROMETER

⑱ VERNIER BEVEL PROTRACTOR
VERNIER BEVEL PROTRACTOR

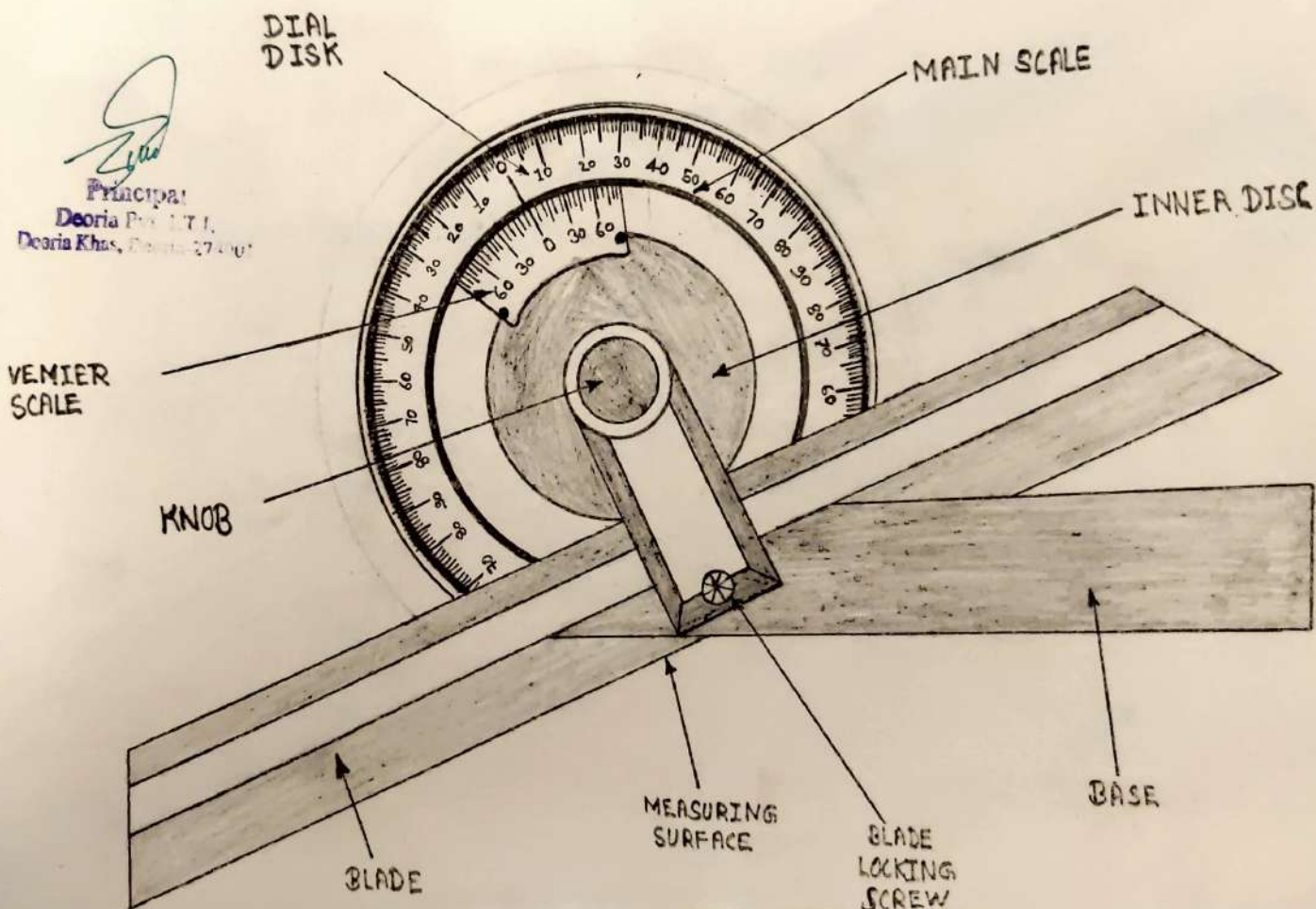

[Signature]
Principal
Deoria P.S. M.T.I.
Deoria Khas, District 27401

SCRIPER

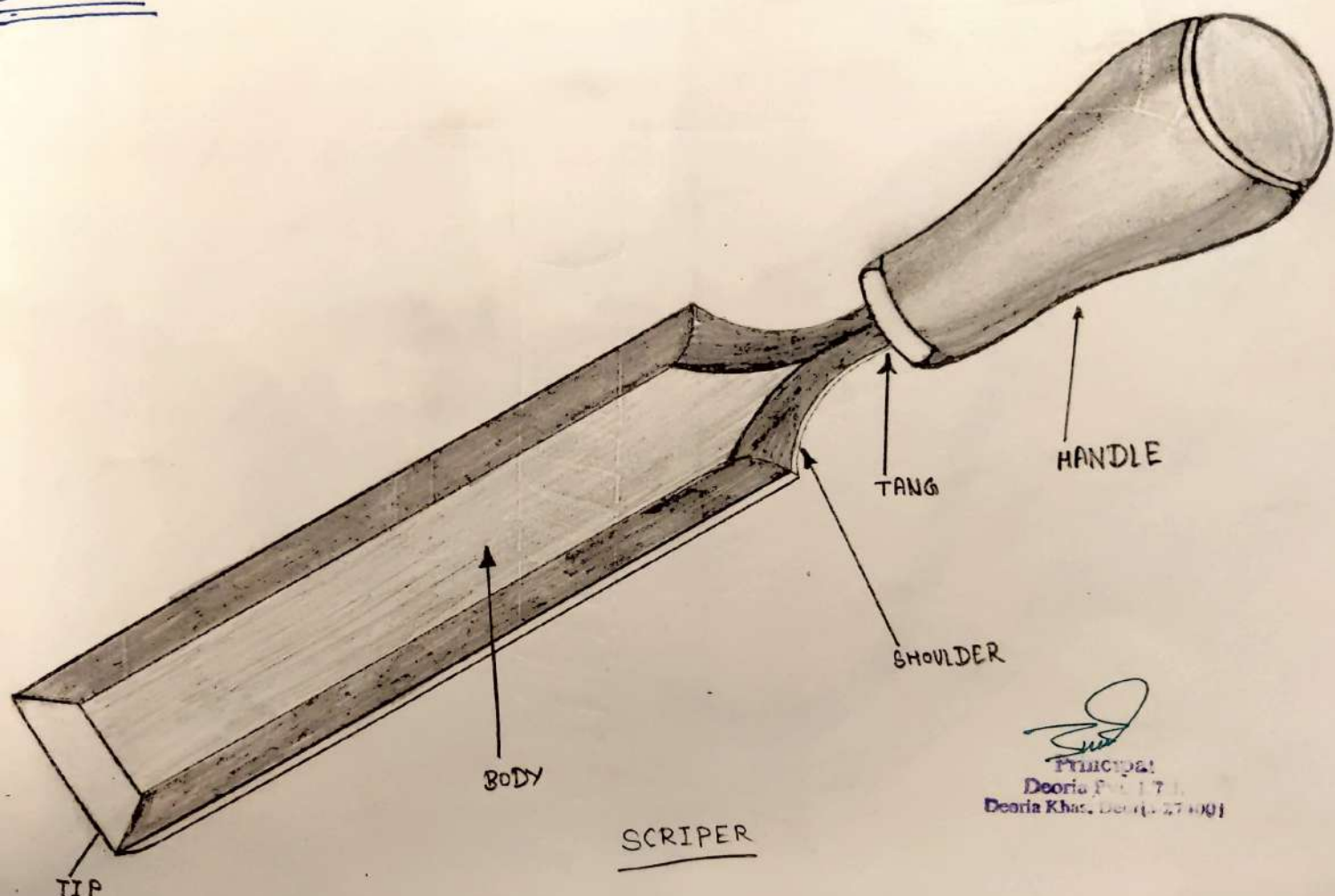

BODY

TIP

TANG

HANDLE

SHOULDER

SCRIPER

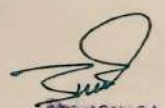
Principal
Deoria P.S. (171)
Deoria Khaz. Dist. (271001)